

正面図 S=1/15

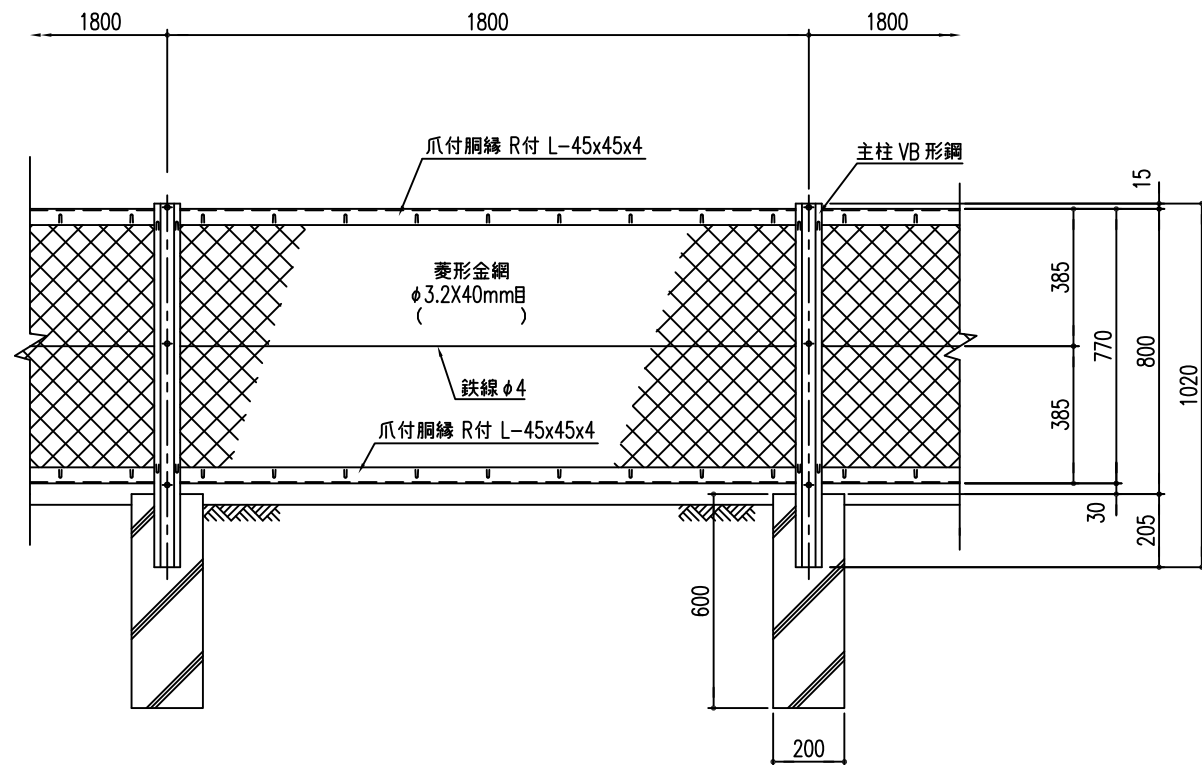

側面図 S=1/15

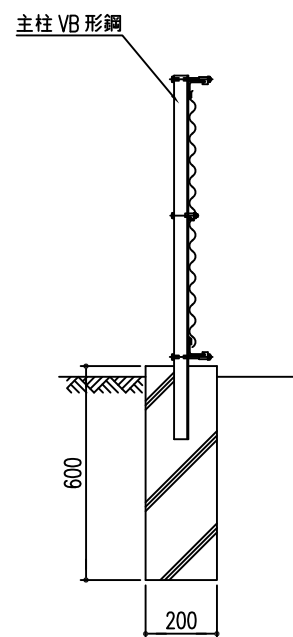

上胴縁取付詳細 S=1/5

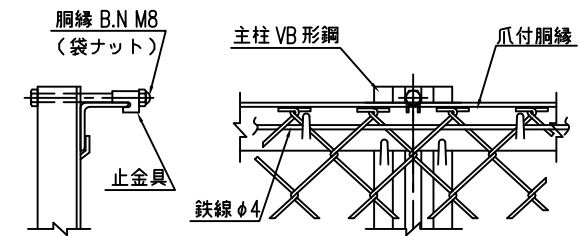

隅柱取付詳細 S=1/5

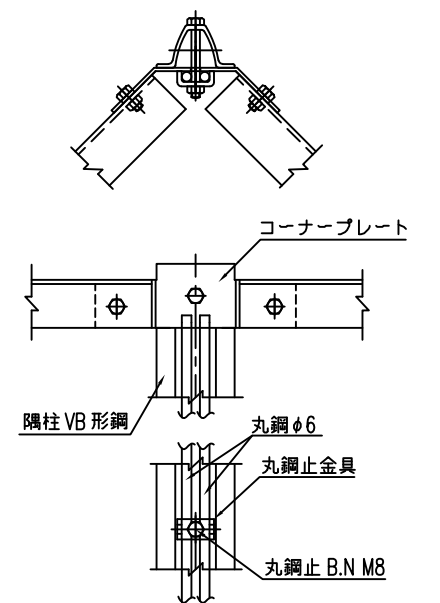

鉄線取付詳細 S=1/5

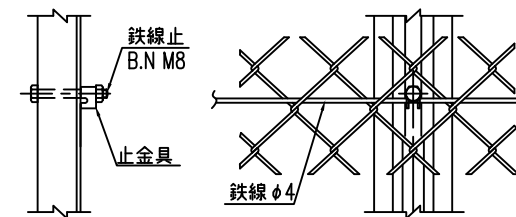

直角隅柱取付詳細 S=1/5

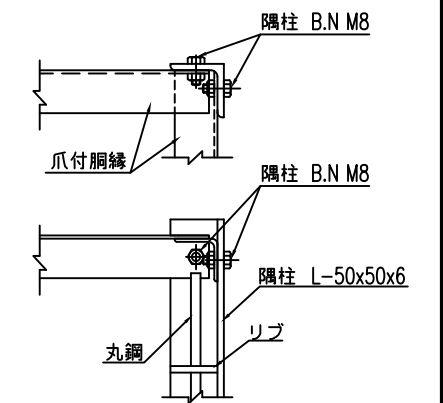

下胴縁取付詳細 S=1/5

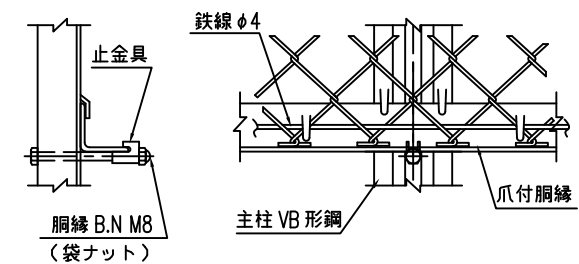

主柱断面図 (VB) S=1/1

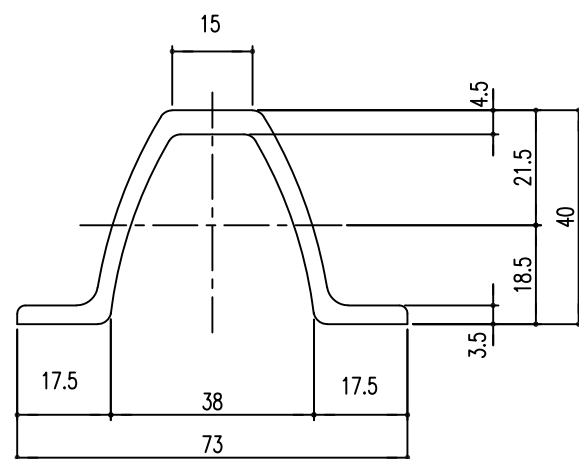

胴縁断面図 S=1/1

(R付 L45x45x4)

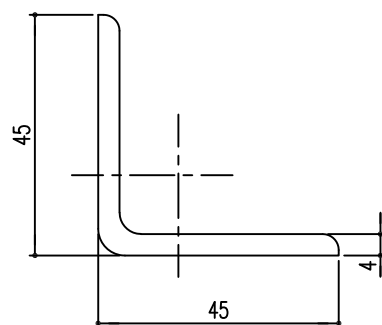

胴縁継手取付詳細 S=1/5

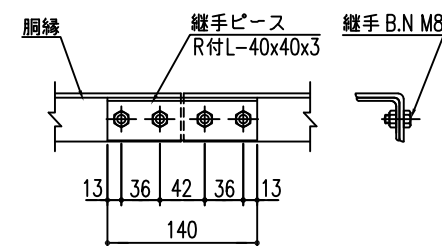

端柱取付詳細 S=1/5

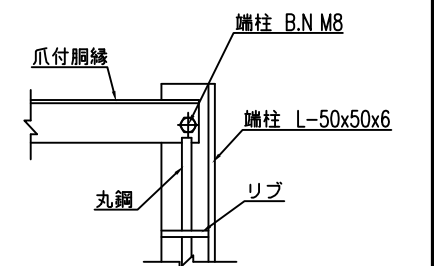

(設計条件) 風荷重: 昭和57年改正 建築基準法・同施行令に基づく風圧力に準拠。
(基礎条件) 長期許容地耐力98kN/m²の場合。

型式	VB5型H80	No.	Vb5h08k-h
JFE 建材株式会社			