

正面図
(S=1/20)

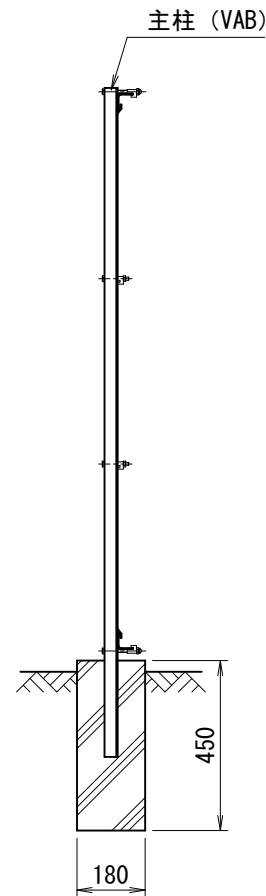

側面図
(S=1/20)

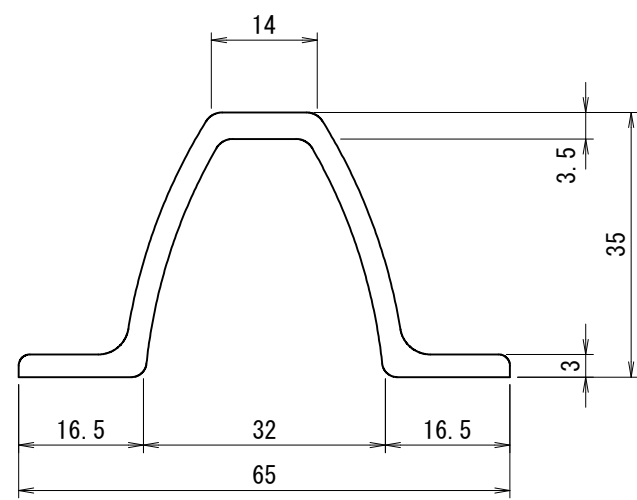

主柱断面図 (VAB)
(S=1/1)

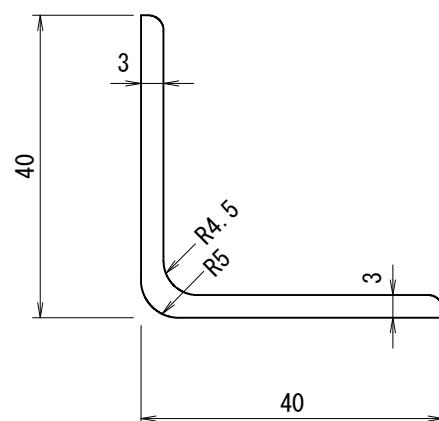

胴縁断面図 (R付L40x40x3)
(S=1/1)

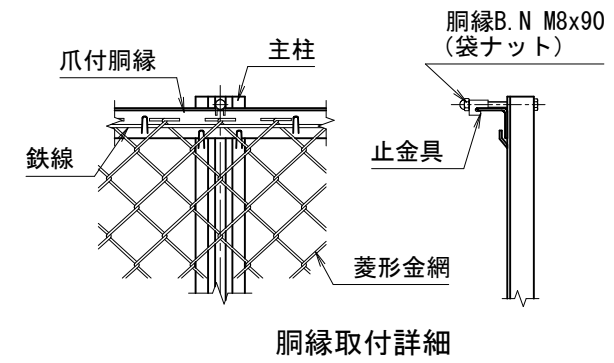

胴縁取付詳細

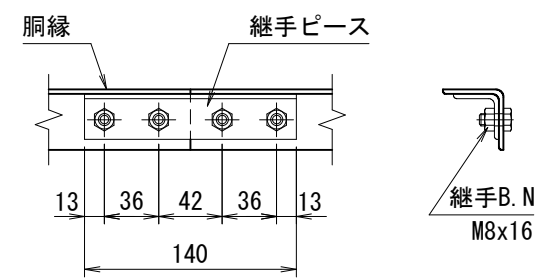

継手ピース取付詳細

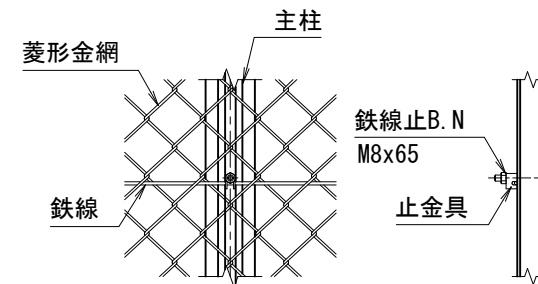

中間鉄線取付詳細

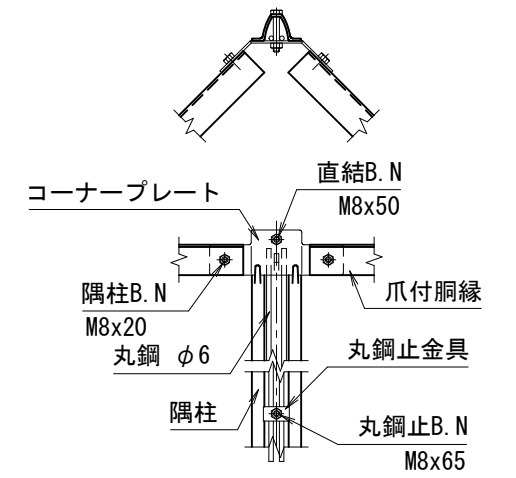

隅柱取付詳細

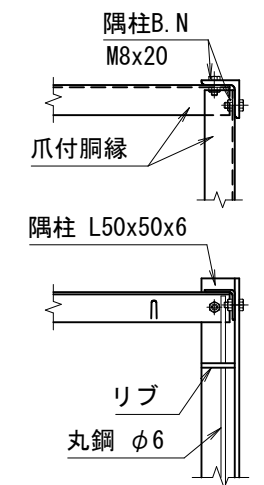

直角隅柱取付詳細

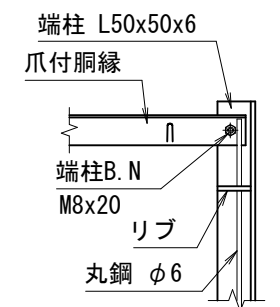

端柱取付詳細

型式	VAB5型H1500	No.	Vab5h15
----	------------	-----	---------

JFE 建材株式会社

(設計条件) 風荷重: 昭和57年改正 建築基準法・同施行令に基づく風圧力に準拠。
(基礎条件) 長期許容地耐力98kN/m²の場合。