

正面図 S=1/15

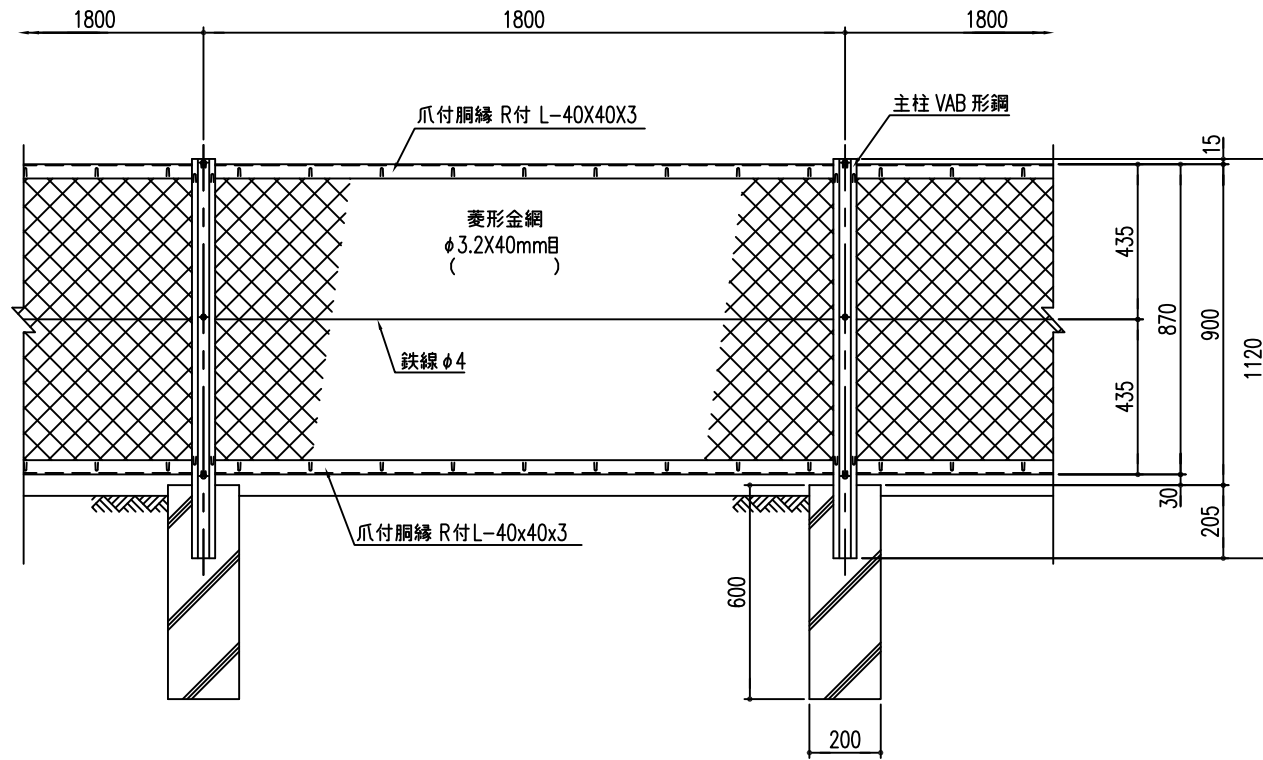

側面図 S=1/15

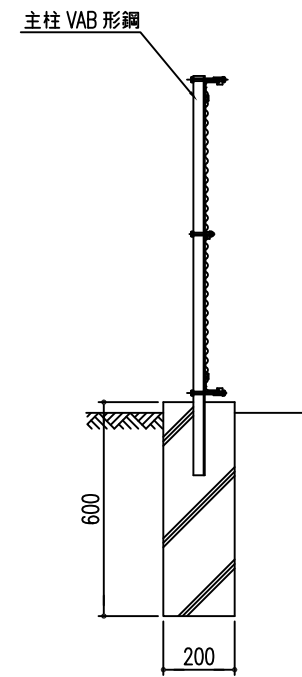

上胴縁取付詳細 S=1/5

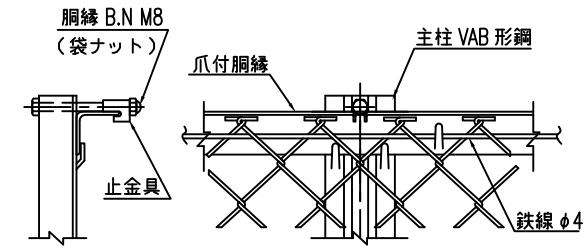

隅柱取付詳細 S=1/5

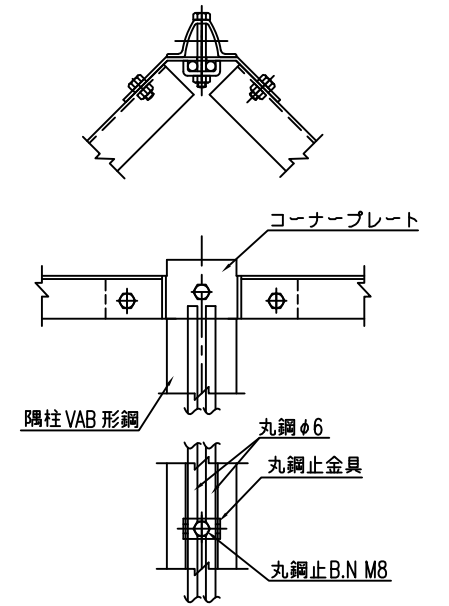

鉄線取付詳細 S=1/5

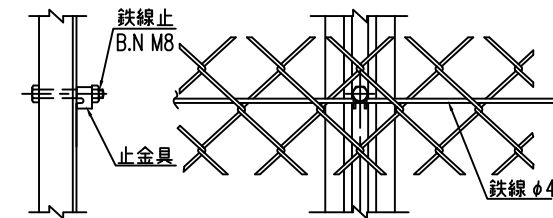

下胴縁取付詳細 S=1/5

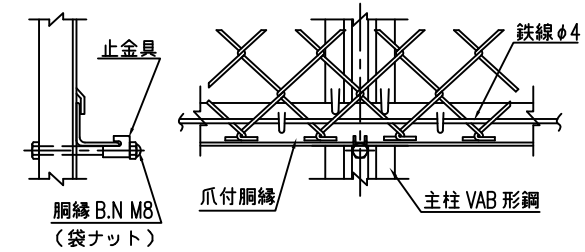

直角隅柱取付詳細 S=1/5

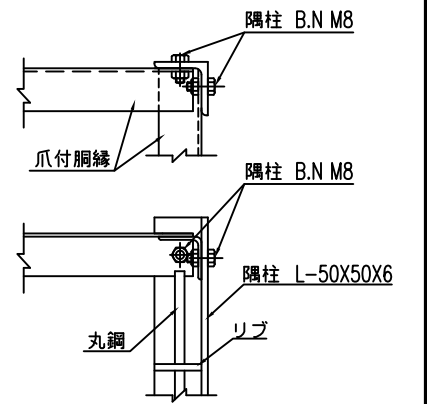

主柱断面図(VAB) S=1/1

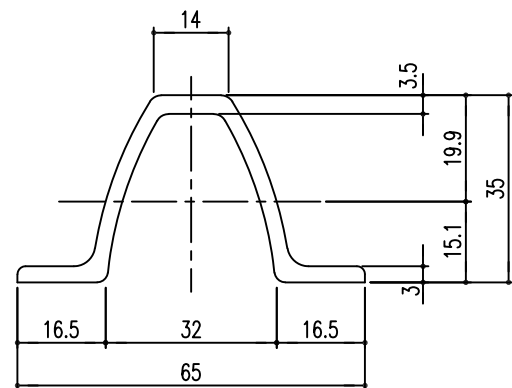

胴縁断面図 S=1/1
(R付L40x40x3)

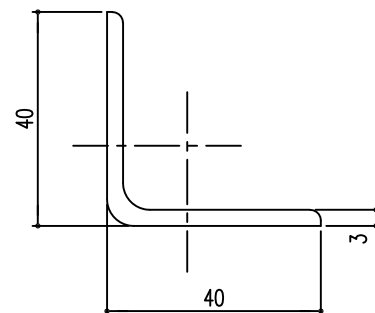

継手ピース取付詳細 S=1/5

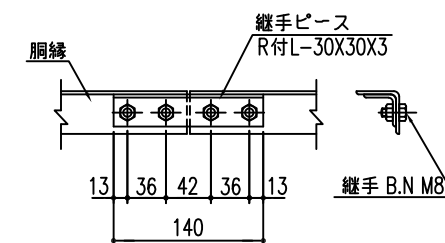

端柱取付詳細 S=1/5

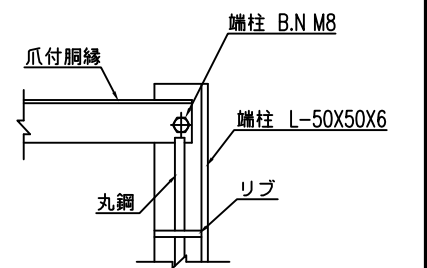

(設計条件) 風荷重：昭和57年改正 建築基準法・同施行令に基づく風圧力に準拠。
(基礎条件) 長期許容地耐力98kN/m²の場合。

型式	VAB5型H900	No.	Vab5h09k-h
JFE 建材株式会社			