

正面図
(S=1/20)

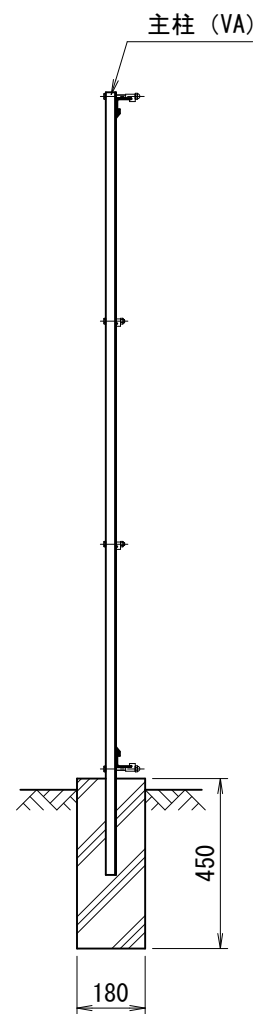

側面図 (控無)
(S=1/20)

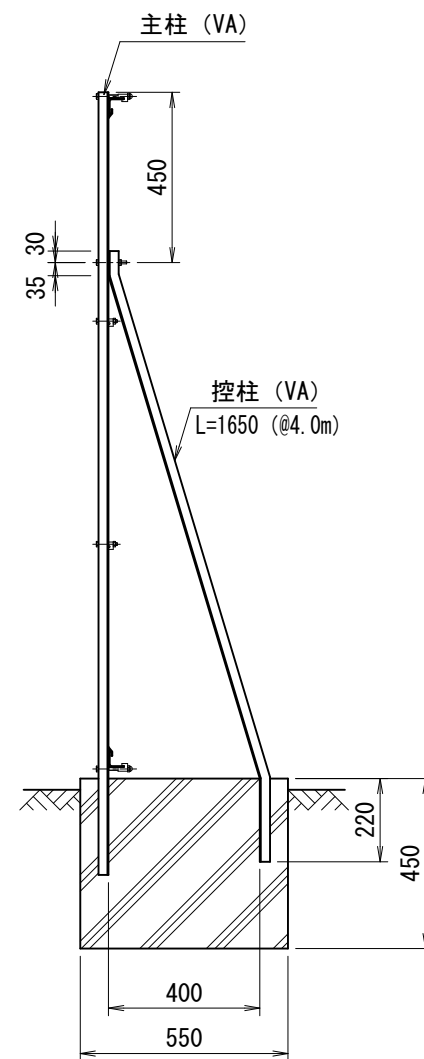

側面図 (控付)
(S=1/20)

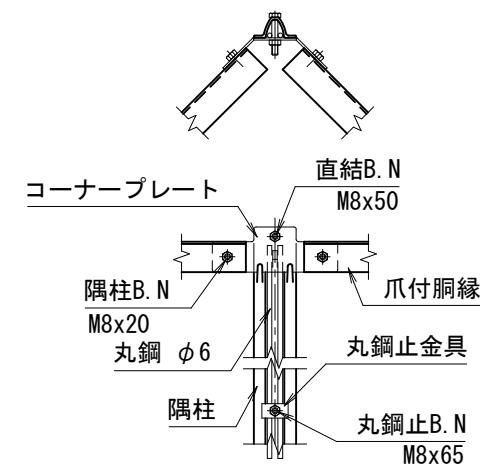

隅柱取付詳細

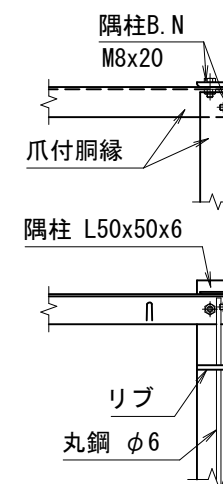

直角 隅柱取付詳細

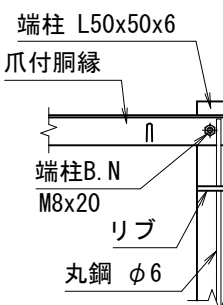

端柱取付詳細

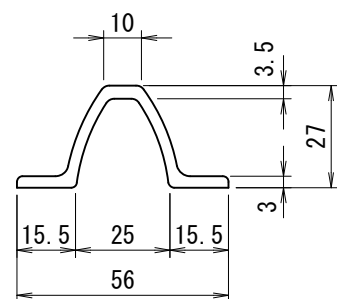

主柱断面図 (VA)
(S=1/2)

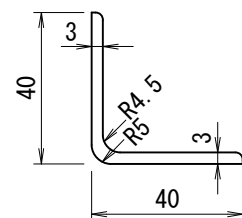

胴縁断面図 (R付L40x40x3)
(S=1/2)

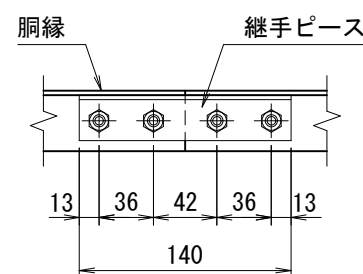

継手ピース取付詳細

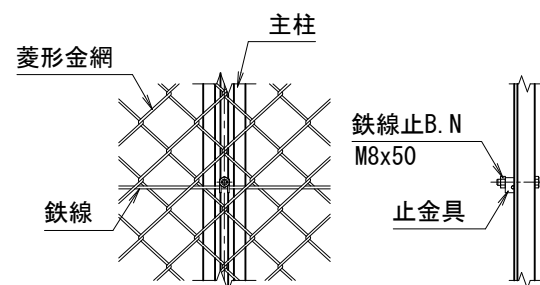

中間鉄線取付詳細

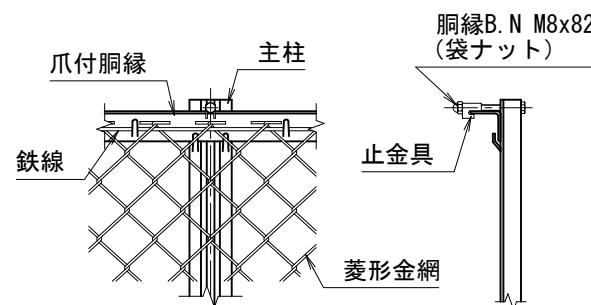

胴縁取付詳細

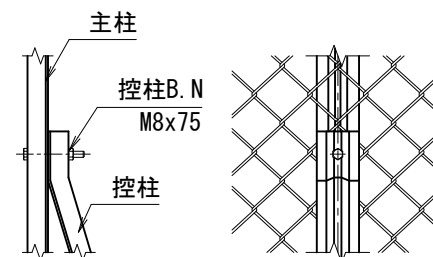

控柱取付詳細

(仕様) 主要部材：ポリエステル樹脂静電粉体塗装
菱形金網：再生PET樹脂被覆鉄線
B.N類：溶融亜鉛めっき

(設計条件) 風荷重：昭和57年改正 建築基準法・同施行令に基づく風圧力に準拠。

(基礎条件) 長期許容地耐力98kN/m²の場合。

 エコマーク認定番号 22 131 001		
型式	VA5PET型H1800	No. Va5h18pet
JFE 建材株式会社		