

SU-TT-G (片引) H1500×W4000

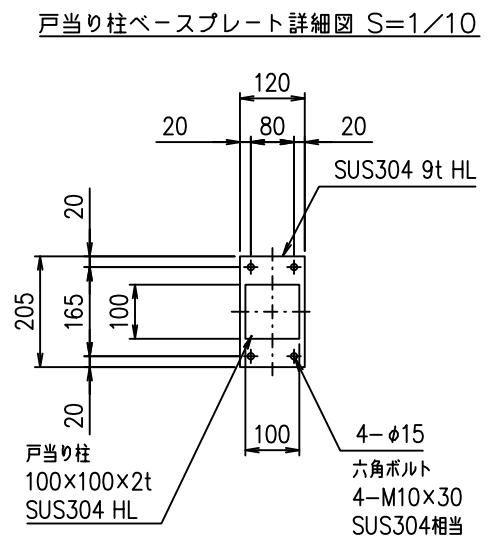
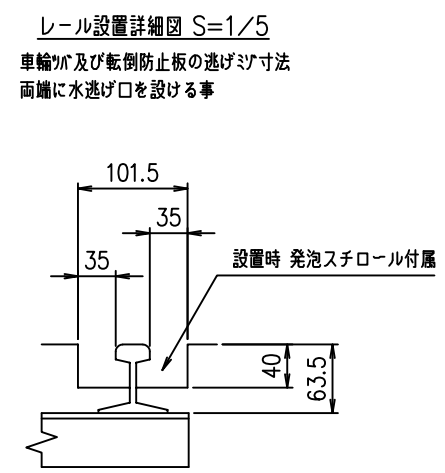
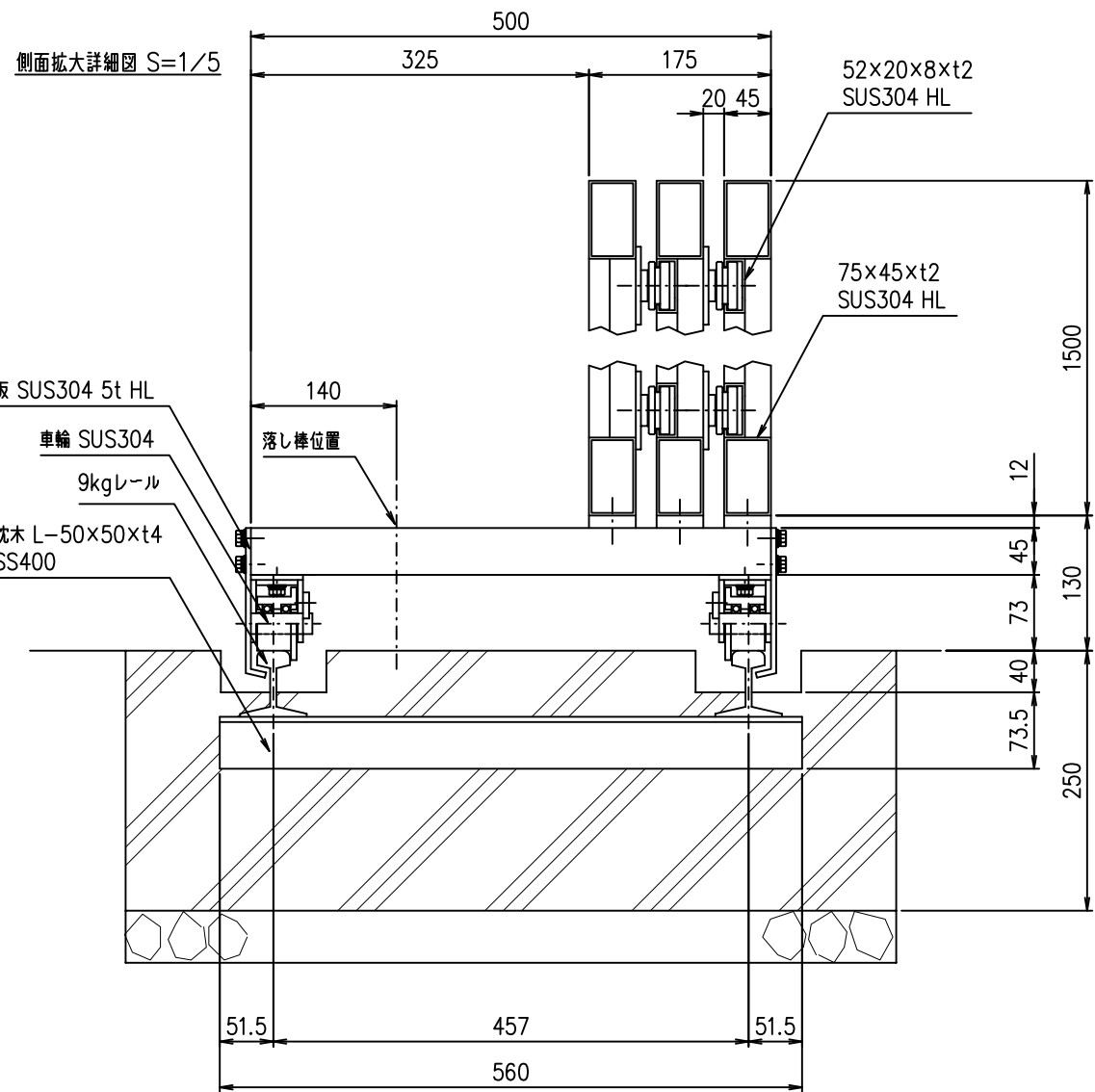
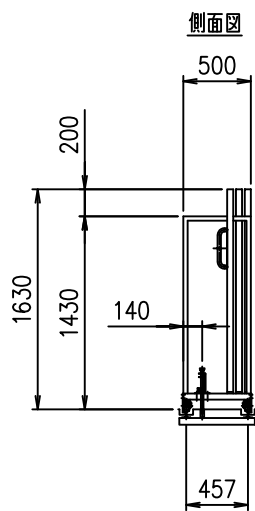
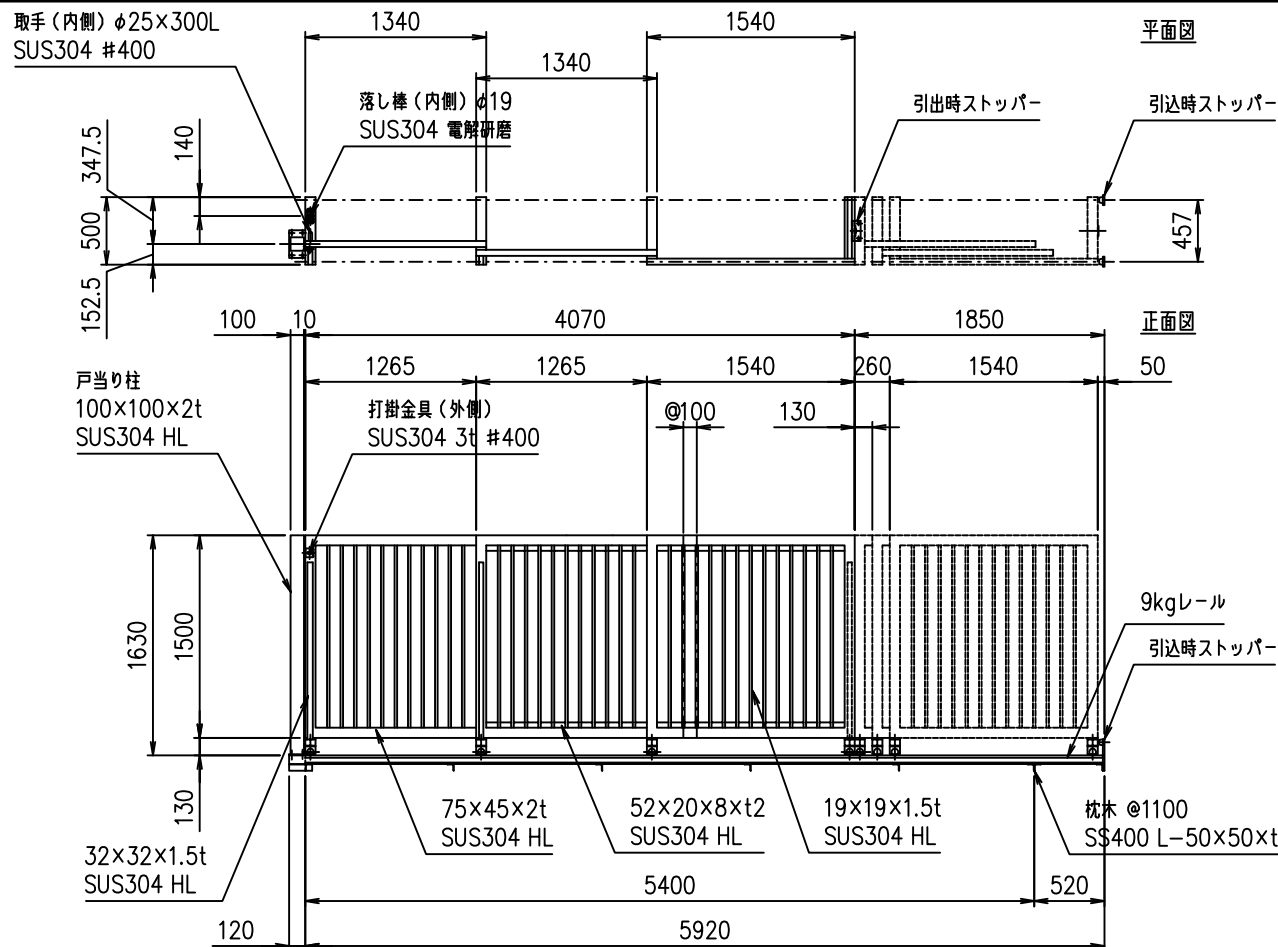

(設計条件) 風荷重: 昭和57年改正 建築基準法・同施行令に基づく風圧力に準拠。
 (基礎条件) 長期許容地耐力98kN/m²の場合。

型式	SU-TT-G型 (片引) H1500×4000	No.	Sutt4g15k
JFE 建材株式会社			